

clarion®

Owner's manual
Mode d'emploi
Manual de instrucciones

CZ209

CD/USB/MP3/WMA RECEIVER
AUTORADIO CD/USB/MP3/WMA
RECEPTOR CD/USB/MP3/WMA

CLARION PRODUCT REGISTRATION INFORMATION

For USA and Canada only

www.clarion.com

Dear Customer:

Congratulations on your purchase of a Clarion mobile electronic products. We are confident that you'll enjoy your Clarion experience.

There are many benefits to registering your product. We invite you to visit our website at **www.clarion.com** to register your Clarion product.

We have made product registration simple with our easy to use website. The registration form is short and easy to complete. Once you're registered, we can keep you informed of important product information.

Register at **www.clarion.com** - it's easy to keep your Clarion product up to date.

INFORMATIONS DE L'ENREGISTREMENT DE PRODUITS CLARION

Pour les États Unis et le Canada seulement

www.clarion.com

Cher client:

Nous vous remercions d'avoir acheté ce produit électronique mobile Clarion. Nous sommes confiants que vous apprécierez votre expérience Clarion.

Il y a beaucoup d'avantage à enregistrer votre produits. Nous vous invitons à visiter notre site Web **www.clarion.com** pour enregistrer votre produit Clarion.

Nous avons facilité la tâche d'enregistrement de produit simple et facile grâce à notre site Web. Le formulaire d'enregistrement est court et facile à compléter. Lorsque vous êtes enregistrer, nous pouvons vous tenir informé des informations important de produits.

Enregistrer à **www.clarion.com** - c'est facile de mettre à jour votre produit Clarion.

INFORMACIÓN DEL REGISTRO DE PRODUCTO DE CLARION

Para USA y Canada nomas

www.clarion.com

Querido Cliente:

Felicitaciones por su compra de producto electrónico móvil de Clarion. Estamos seguros que usted gozará de su experiencia con el producto de Clarion.

Hay muchas ventajas al registrar su producto. Le invitamos a que visite nuestro sitio en internet **www.clarion.com** para registrar su producto de Clarion.

Hemos hecho el registro de producto fácil en nuestro sitio. La forma de registro es corta y fácil de completar. Una vez que lo registre, podremos proporcionarle la información de su producto.

Regístrese en **www.clarion.com** - es fácil mantener su producto de Clarion actualizado.

Thank you for purchasing this **Clarion** product.

- * Please fully read this owner's manual before operating this equipment.
- * Check the contents of the enclosed warranty card and store it in a safe place with this manual.

Contents

1. FEATURES	3
2. PRECAUTIONS	4
3. CONTROLS	5
Names of the Buttons and Their Main Functions	5
4. DCP (DETACHABLE CONTROL PANEL)	6
5. REMOTE CONTROL	7
Functions of Remote Control Unit Buttons	7
Inserting the Battery	8
6. OPERATIONS	8
Basic Operations	8
Radio Operations	10
CD/MP3/WMA Operations	11
Operations Common to Each Mode	14
7. ACCESSORIES	15
USB Operations	15
iPod Operations	17
8. TROUBLESHOOTING	20
9. ERROR DISPLAYS	21
10. SPECIFICATIONS	22

1. FEATURES



- USB Audio for iPod
- 4ch/2V RCA Output with Non Fader Volume Control
- Front Panel 3.5mm Auxiliary Input

2. PRECAUTIONS

This equipment has been tested and found to comply with the limits for a Class B digital device, pursuant to Part 15 of the FCC Rules.

These limits are designed to provide reasonable protection against harmful interference in a residential installation.

This equipment generates, uses, and can radiate radio frequency energy and, if not installed and used in accordance with the instructions, may cause harmful interference to radio communications. However, there is no guarantee that interference will not occur in a particular installation.

If this equipment does cause harmful interference to radio reception, which can be determined by turning the equipment off and on, the user is encouraged to consult the dealer or an experienced radio technician for help.

MODEL clarion

12V ⚡ GROUND
AM 530-1710kHz / FM 87.9-107.9MHz

THIS DEVICE COMPLIES WITH PART 15 OF THE FCC RULES. OPERATION IS SUBJECT TO THE FOLLOWING TWO CONDITIONS:
(1) THIS DEVICE MAY NOT CAUSE HARMFUL INTERFERENCE, AND
(2) THIS DEVICE MUST ACCEPT ANY INTERFERENCE RECEIVED, INCLUDING INTERFERENCE THAT MAY CAUSE UNDESIREED OPERATION.

THIS PRODUCTION COMPLIES WITH DHHS RULES 21 CFR SUBCHAPTER J APPLICABLE AT DATE OF MANUFACTURE.

CLARION CO.,LTD
7-2, SHINTOSHIN,CHUO-KU,SAITAMA-SHI,SAITAMA 330-0081,JAPAN

This product includes technology owned by Microsoft Corporation and cannot be used or distributed without a license from MSLGP.

MANUFACTURED:

LF 2764
Clarion Co., Ltd.
MADE IN

SERIAL No. PE-

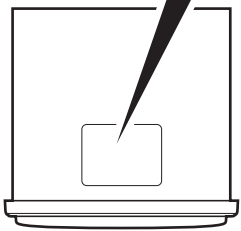

⚠ CAUTION

USE OF CONTROLS, ADJUSTMENTS, OR PERFORMANCE OF PROCEDURES OTHER THAN THOSE SPECIFIED HEREIN, MAY RESULT IN HAZARDOUS RADIATION EXPOSURE.

THE COMPACT DISC PLAYER SHOULD NOT BE ADJUSTED OR REPAIRED BY ANYONE EXCEPT PROPERLY QUALIFIED SERVICE PERSONNEL.

CHANGES OR MODIFICATIONS NOT EXPRESSLY APPROVED BY THE MANUFACTURER FOR COMPLIANCE COULD VOID THE USER'S AUTHORITY TO OPERATE THE EQUIPMENT.

INFORMATION FOR USERS:

CHANGES OR MODIFICATIONS TO THIS PRODUCT UNAPPROVED BY THE MANUFACTURER WILL VOID THE WARRANTY AND VIOLATE FCC APPROVAL.

Handling Compact Discs

- Compared to ordinary music CDs, CD-R and CD-RW discs are easily affected by high temperatures and humidity, potentially making them unplayable. Therefore, do not to leave them in the car for a long time.
- Do not stick labels on compact discs or mark the surface with pens or pencils.

Display Screen

- In extreme cold, the screen movement may slow down and the screen may darken, but this is normal. The screen will recover when it returns to normal temperature.

3. CONTROLS

Names of the Buttons and Their Main Functions

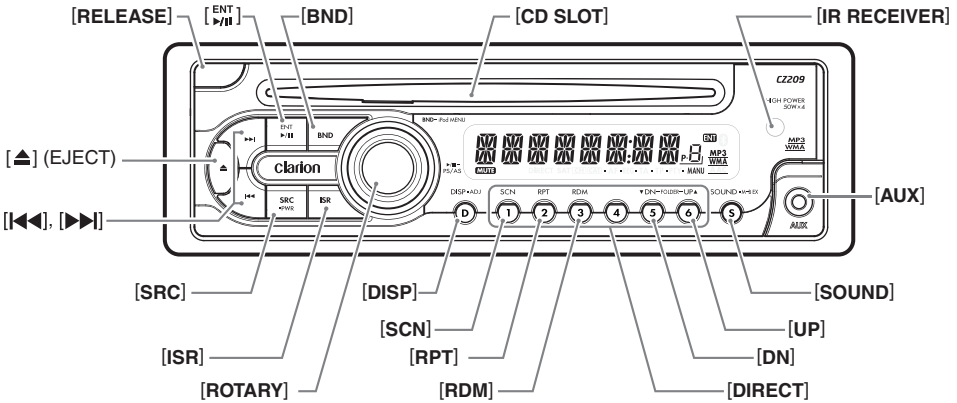

[RELEASE] button

- Press to unlock DCP.

[ENT] button

- Perform preset scan while in the radio mode.
- Play or pause a track while in CD/MP3/WMA/USB/iPod mode.

[BND] button

- Change bands, or select seek tuning or manual tuning while in radio mode.

[CD SLOT]

- Insert CDs here.

[IR RECEIVER]

- Receiver for remote control unit. (Operating range: 30° all directions)

[AUX] input jack

- Input jack for connecting external device.

[SOUND] button

- Press to switch to the sound adjust mode.

[UP], [DN] buttons

- Select folders while in MP3/WMA/USB mode.

[DIRECT] buttons

- Store radio stations in memory or recall it directly while in radio mode.

[RDM] button

- Perform random play while in CD/MP3/WMA/USB/iPod mode.

[RPT] button

- Perform repeat play while in CD/MP3/WMA/USB/iPod mode.

[SCN] button

- Perform scan play in CD/MP3/WMA/USB mode.

[DISP] button

- Switch display mode.

[ROTARY] knob

- Rotate to adjust the volume.

[ISR] button

- Recall ISR station stored in memory.
- Press and hold (2 sec.) to store current station in ISR memory (radio mode only).

[SRC] button

- Turn the power on/off.

[⏮, ⏭] buttons

- Commence fast-forward/fast-reverse mode.

[▲] (EJECT) button

- Press to eject disc.

4. DCP (DETACHABLE CONTROL PANEL)

Removing the DCP

1. Press and hold the [SRC] button (1 sec.) to switch off power.
2. Press the [RELEASE] button.

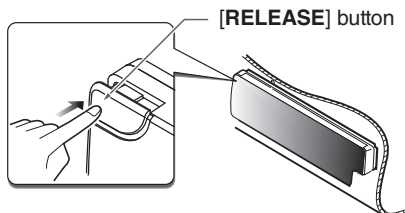

* DCP is unlocked.

3. Remove DCP.

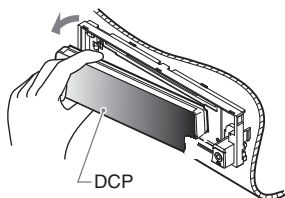

Attaching the DCP

1. Insert the right end of DCP into main unit.
2. Press left end of DCP into main unit.

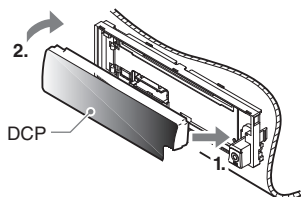

CAUTION

- After removal, be careful not to drop the DCP or subject it to strong impacts, to prevent damage.
- Once the [RELEASE] button is pressed and the DCP is unlocked, car vibrations can cause the DCP to fall.
- The connector for the main unit and DCP is extremely important. Be careful not to damage it by pressing with fingernails or sharp objects.

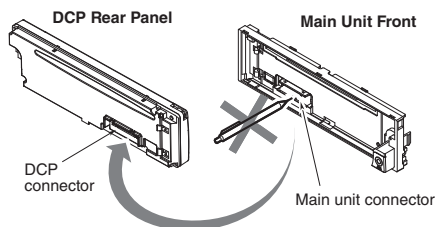

Note:

- If the DCP is dirty, wipe off with a soft, dry cloth only.

5. REMOTE CONTROL

Functions of Remote Control Unit Buttons

* Some buttons on the remote have different functions from those on the main unit.

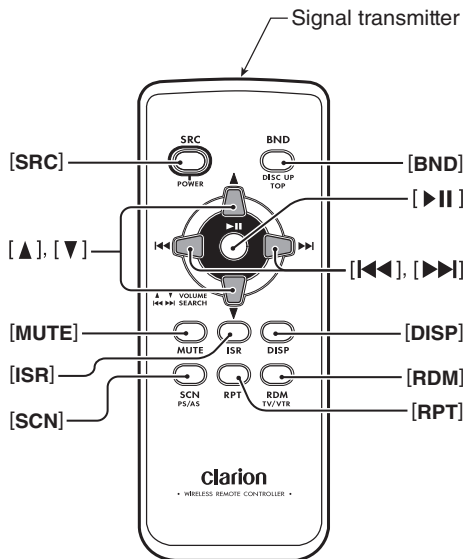

● Shared modes

[SRC] button

- Press to turn on power.
- Press and hold (1 sec.) to turn off power.
- Use to change operation mode.

[▲], [▼] buttons

- Increases/decreases volume.

[MUTE] button

- Turns mute function on/off.

[ISR] button

- Recalls ISR station stored in memory.
- Press and hold (2 sec.) to store current station in ISR memory (radio mode only).

[DISP] button

- Press to select desired display.

● Radio mode

[BND] button

- Switches reception band.

[◀◀], [▶▶] buttons

- Change preset channels.

[SCN] button

- Press for preset scan play.
- Press and hold (2 sec.) for auto store.

● CD/MP3/WMA/USB modes

[◀◀], [▶▶] buttons

- Press to select tracks.
- Press and hold (1 sec.) for fast-forward/fast-reverse.

[▶||] button

- Switches between playback and pause.

[SCN] button

- Press for scan play.
- In MP3/WMA/USB mode, press and hold (1 sec.) for folder scan play.

[RPT] button

- Press for repeat play.
- In MP3/WMA/USB mode, press and hold (1 sec.) for folder repeat play.

[RDM] button

- Press for random play.
- In MP3/WMA/USB mode, press and hold (1 sec.) for folder random play.

● iPod mode

[◀◀], [▶▶] buttons

- Press to select tracks.
- Press and hold (1 sec.) for fast-forward/fast-reverse.

[▶||] button

- Switches between playback and pause.

[RPT] button

- Press for repeat play.

[RDM] button

- Press for random play.
- Press and hold (1 sec.) for all random play.

Inserting the Battery

- ① Slide remote control unit's rear cover in the direction shown.
- ② Insert battery (CR2025) into insertion guides with printed side (+) up.
- ③ Press battery into compartment as shown.
- ④ Replace and slide cover until it clicks into place.

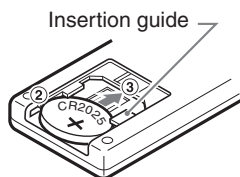
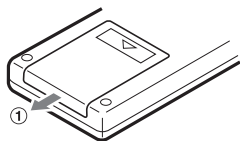

Notes:

Misuse may result in battery rupture and fluid leakage, resulting in personal injury or damage. Always follow these safety precautions:

- Use only the designated battery.
- When replacing the battery, insert with +/- polarities correctly oriented.
- Do not subject battery to heat, or dispose in fire or water. Do not attempt to disassemble the battery.
- Dispose of used batteries properly.

6. OPERATIONS

Note:

- Refer to the diagrams in "3. CONTROLS" (page 5) when reading this chapter.

Basic Operations

⚠ CAUTION

Be sure to lower the volume before switching off the unit power or car's ignition key. The unit remembers its last volume setting.

Turning power on/off

1. Press the [SRC] button to turn on power.
2. Press and hold the [SRC] button (1 sec.) to turn off power.

Selecting modes

1. Press the [SRC] button to change operation mode.
2. Each time the [SRC] button is pressed, the operation mode changes as follows:
Radio → CD/MP3/WMA → USB/iPod → AUX → Radio...

An iPod can be connected via a USB cable.

Adjusting the volume

1. Turn the [ROTARY] knob clockwise to increase volume; turn counterclockwise to decrease volume.

* Volume range is 0 (minimum) to 33 (maximum).

Switching the display

Press the [DISP] button to select desired display.

Sound Adjustment

Sound effects and tone can be adjusted as desired.

To change sound settings

1. Press the [SOUND] button to switch to the sound adjustment display.
 - * The factory default sound setting is “Z-EHCR+”.
2. Press [◀◀] or [▶▶] to select the sound adjustment mode.

Each time [◀◀] or [▶▶] is pressed, the sound adjustment mode changes as follows:

“Z-EHCR+” ↔ “BASS” ↔ “TREBLE” ↔ “BALANCE” ↔ “FADER” ↔ “NF VOL”

 - * When “ENT” is flashing in the display, press the [ENT] button to adjust the setting value.
 - * The sound adjustment mode is displayed for 2 seconds before showing the sound setting.
3. Turn the [ROTARY] knob to adjust the selected audio mode.
4. After completing settings, press the [SOUND] button to return to the previous mode.

● Setting the Z-Enhancer Plus

This unit has 4 sound tone effects stored in memory.

Select the effect you prefer.

* The factory default setting is “OFF”.

2-1. Select “Z-EHCR+”.

3-1. When you turn the [ROTARY] knob, the tone effect changes as follows:

“OFF” ↔ “B-BOOST” ↔ “IMPACT” ↔ “EXCITE” ↔ “CUSTOM”

OFF : No sound effect

B-BOOST : Enhanced bass

IMPACT : Enhanced bass and treble

EXCITE : Enhanced bass, mid, and treble

CUSTOM : User customized

When set to “B-BOOST/IMPACT/EXCITE”:

3-2. Press the [ENT] button.

3-3. Turn the [ROTARY] knob to adjust the setting (Setting range: -3 to +3).

* The factory default setting is “0”.

3-4. Press the [ENT] button to return to the previous mode.

When set to “CUSTOM”:

3-2. Press and hold the [ENT] button (1 sec.). Bass/treble characteristics become flat and “FLAT” is show in the display.

3-3. Turn the [ROTARY] knob to change to the “OFF” mode.

● Adjusting the bass

This adjustment is supported only when Z-Enhancer Plus is set to “CUSTOM”.

2-1. Select “BASS”.

3-1. Press the [ENT] button.

3-2. Press [◀◀] or [▶▶] to change and select settings as follows:

“B<G 0>” ↔ “B<F 60>” ↔ “Q 1”

3-3. Turn the [ROTARY] knob to adjust values for gain, F (center frequency) and Q curve.

B<G 0> : The factory default setting is “0”.
(Adjustment range: +7 to -7)

B<F 60> : The factory default setting is “60”.
(Adjustment range: 60/80/100/200)

Q 1 : The factory default setting is “1”.
(Adjustment range: 1/1.25/1.5/2)

3-4. Press the [ENT] button to return to the previous mode.

● Adjusting the treble

This adjustment is supported only when Z-Enhancer Plus is set to “CUSTOM”.

2-1. Select “TREBLE”.

3-1. Press the [ENT] button.

3-2. Press [◀◀] or [▶▶] to change and select settings as follows:

“T<G 0>” ↔ “T<F 10K>”

3-3. Turn the [ROTARY] knob to adjust values for gain and F (center frequency).

T<G 0> : The factory default setting is “0”.
(Adjustment range: +7 to -7)

T<F 10K>: The factory default setting is “10K”.
(Adjustment range: 10K/12.5K/15K/17.5K)

3-4. Press the [ENT] button to return to the previous mode.

● Adjusting the balance

- 2-1. Select "**BALANCE**".
- 3-1. Turn the **[ROTARY]** knob to adjust balance between right and left speakers.
 - * The factory default setting is "**CENTER**". (Adjustment range: RIGHT12 to LEFT12)

● Adjusting the fader

- 2-1. Select "**FADER**".
- 3-1. Turn the **[ROTARY]** knob to adjust balance between front and rear speakers.
 - * The factory default setting is "**CENTER**". (Adjustment range: FRONT12 to REAR12)

● Adjusting the non-fader volume

Adjust volume output from the unit's non-fader output terminal.

- 2-1. Select "**NF VOL**".
- 3-1. Turn the **[ROTARY]** knob clockwise to increase volume; turn counterclockwise to decrease volume.
 - * The factory default setting is "0". (Adjustment range: +6 to -6)

Note:

- *When in the sound adjustment mode, if no operation is performed for 10 seconds or more, the mode is cancelled and the unit returns to the previous mode.*

Setting the MAGNA BASS EXTEND

The MAGNA BASS EXTEND function does not adjust low frequencies like normal sound adjustments, but emphasizes the deep bass range with dynamic sound.

- * The factory default setting is "**OFF**".
1. Press and hold the **[SOUND]** button (1 sec.) to enable MAGNA BASS EXTEND.
 2. Press and hold the **[SOUND]** button (1 sec.) to disable MAGNA BASS EXTEND.

Radio Operations

Listening to broadcasts

1. Press the **[SRC]** button and select radio mode.
2. Press the **[BND]** button and select the reception band. Each time the button is pressed, the band changes as follows:
F1 (FM1) → F2 (FM2) → F3 (FM3) → AM → F1 (FM1)...

Tuning

3 tuning modes are available: seek tuning, manual tuning and preset tuning.

Seek tuning

1. Press the **[BND]** button and select the desired band (FM/AM).
 - * If "**MANU**" appears in the display, press and hold the **[BND]** button (1 sec.). "**MANU**" will turn off, and seek tuning will be enabled.
2. Press **[◀◀]** or **[▶▶]** to automatically seek a station.

Manual tuning

2 modes are available: Quick tuning and step tuning.

● Quick tuning

Press and hold **[◀◀]** or **[▶▶]** (1 sec.) to tune a station.

● Step tuning

Press **[◀◀]** or **[▶▶]** to manually tune a station.

Recalling a preset station

A total of 24 preset positions (6-FM1, 6-FM2, 6-FM3, 6-AM) can be used to store broadcast stations in memory. Press the corresponding **[DIRECT]** button to automatically recall the stored frequency.

Manual memory

1. Use seek tuning or manual tuning to select the desired station.
2. Press and hold one of the [DIRECT] buttons (2 sec.) to store the current station in preset memory.

Auto store

The auto store function stores up to 6 stations automatically tuned in sequential order. If 6 stations cannot be found, any previously stored station remains in its memory position.

1. Press the [BND] button and select the desired band (FM/AM).
2. Press and hold the [ENT] button (2 sec.). The stations with good reception are stored automatically to the preset channels.
 - * If auto store is performed in the FM bands, the stations are stored in FM3 even if FM1 or FM2 was chosen for storing stations.

Preset scan

Preset scan sequentially receives stations stored in preset memory. This function is useful when searching for a station stored in the memory.

1. Press the [ENT] button.
2. When the desired station is received, press the [ENT] button again to continue receiving that station.

Note:

- Do not press and hold the [ENT] button (2 sec.), or the auto store function will begin and the unit will begin storing stations.

Instant station recall (ISR)

The ISR function allows instant access to a favorite preset station. The function operates even when the unit is in other modes.

● ISR memory

1. Select the station you wish to store in ISR memory.
2. Press and hold the [ISR] button (2 sec.).

● Recalling a station with ISR

While in any mode, press the [ISR] button to turn on the radio function and tune the selected station. "ISR" appears on the display. Press the [ISR] button again to return to the previous mode.

CD/MP3/WMA Operations

MP3/WMA

This unit supports to play MP3/WMA files.

Notes:

- If you play a WMA file with active DRM (Digital Rights Management), no audio is output (WMA indicator flashes).
 - Windows Media™, and the Windows® logo are trademarks, or registered trademarks of Microsoft Corporation in the United States and/or other countries.
- #### ● To disable DRM (Digital Rights Management)
1. In Windows Media Player 9/10/11, click on TOOL → OPTIONS → MUSIC RECORD tab. Under Recording settings, unclick the check box for RECORD PROTECTED MUSIC. Then reconstruct files. Use personally constructed WMA files at your own responsibility.

Precautions when creating MP3/WMA files

● Usable sampling rates and bit rates

1. MP3: Sampling rate: 8 kHz-48 kHz, Bit rate: 8 kbps-320 kbps / VBR
2. WMA: Bit rate: 48 kbps-192 kbps

● File extensions

1. Always add a file extension ".MP3" or ".WMA" to MP3 or WMA files using single byte characters. If a different or no file extension is appended, the file cannot be played.
2. Files without MP3/WMA data will not play. Instead, "--:--" will appear in the play time display.

● Logical format (File system)

1. When writing MP3/WMA files on a CD-R or CD-RW disc, select "ISO9660 level 1, 2, or JOLIET or Romeo" as the software format. Normal playback may not be possible if recorded in other formats.
2. The folder name and file name can be displayed as the title during MP3/WMA play. However titles must be within 64 single byte alphabetical letters and numbers (including extension).
3. Do not affix a name to a file inside a folder with the same name.

● Number of files or folders

1. Up to 256 files can be recognized per folder.
Up to 578 files can be played.
2. Tracks are played in the order they were recorded onto the disc. (Tracks may not always be played in the order displayed on the PC.)
3. Some noise may occur depending on the type of encoder software used for recording.

Disc-In-Play function

This function automatically turns on unit power and begins disc play if a disc is inserted when the car's ignition key is turned to the ON or ACC position.

⚠ CAUTION

- Do not insert hands, fingers, or other foreign objects into the disc insertion slot.
- Do not insert discs with adhesives such as cellophane tape or rental CD labels attached, or discs with marks left from removal of such adhesives, since the disc may become stuck and damage the unit.

Backup Eject function

Press the [▲] button to eject the disc even when the unit's power is turned off.

1. Press the [▲] button. Remove disc after it is ejected.

Notes:

- If you force a CD in before auto reloading, you may damage the CD.
- If a CD (12 cm) is left ejected for 15 seconds, it will be automatically reloaded (auto reload).

Listening to a disc already loaded in the unit

Press the [SRC] button to select CD/MP3/WMA mode.



When the unit enters this mode, playback starts automatically.

If no disc is loaded, "NO DISC" appears in the title display.

Loading a CD

1. Insert a CD into the centre of the CD SLOT with label facing up. "LOADING" appears in the display, the CD enters the slot, and play begins.

Notes:

- If the CD does not enter easily, another CD may be in the unit, or the unit may require service.
- Discs without the  or  mark and CD-ROMs are not supported.
- Some CD-R/CD-RW discs may not be usable.

Pausing play

1. Press the [ENT] button to pause play. "PAUSE" appears in the display.
2. To resume CD play, press the [ENT] button again.

Displaying CD titles

This unit can display title data for CD-text/MP3/WMA discs.

1. Each time the [DISP] button is pressed, the title display will change.

● CD-TEXT discs

Track → Disc → Artist → Track ...

● MP3/WMA discs

Track → Folder → Title → Album → Artist → Track ...

Notes:

- If the CD playing is not a CD-text disc or no user title has been input, "NO TITLE" appears in the display.
- If an MP3/WMA disc has no Tag input, "NO TITLE" appears in the display.
- This unit supports MP3 ID3 Tags V2.3 / 2.2 / 1.1 / 1.0.
- Tag display gives priority to V2.3 / 2.2.
- For WMA album Tags, the information written into the extension header is displayed.
- ISO8859-1, ASCII, S-JIS characters can be displayed in Tags.
UNKNOWN characters can be turned into ISO8859-1 characters.
- Titles up to 32 bytes can be displayed in CD/MP3/WMA mode.

Selecting a track

● Track advance

1. Press the [▶▶] button to move to the beginning of the next track.
2. Each time the [▶▶] button is pressed, the track advances to the beginning of the next track.

● Track back

1. Press the [◀◀] button to return to the beginning of the current track.
2. Press the [◀◀] button twice to return to the beginning of the previous track.

Fast-forward/fast-reverse

● Fast-forward

1. Press and hold the [▶▶] button (1 sec.).

● Fast-reverse

1. Press and hold the [◀◀] button (1 sec.).
- * For MP3/WMA discs, some time is required until to initiate movement between tracks. Also, some error may occur in the playing time.

Folder select

Select a folder containing MP3/WMA files and begins playing the first track in the folder.

1. Press [UP] or [DN].
Press the [UP] button to move to the next folder. Press the [DN] button to move to the previous folder.
2. To select a track, press [◀◀] or [▶▶].

Other play modes

● Scan play

This function locates and plays the first 10 seconds of all tracks recorded on a disc.

1. Press the [SCN] button for scan play.

● Folder scan play

This function locates and plays the first 10 seconds of the first tracks of all folders on an MP3/WMA disc.

1. Press and hold the [SCN] button (1 sec.) for folder scan play.

● Repeat play

This function plays the current track repeatedly.

1. Press the [RPT] button for repeat play.

● Folder repeat play

Repeatedly plays all tracks of the current folder on an MP3/WMA disc.

1. Press and hold the [RPT] button (1 sec.) for folder repeat play.

● Random play

This function plays all tracks recorded on a disc in random order.

1. Press the [RDM] button for random play.

● Folder random play

This function plays all the tracks of all the folders recorded on an MP3/WMA disc in random order.

1. Press and hold the [RDM] button (1 sec.) for folder random play.

● To cancel play modes

1. Press the button previously selected.
- * The play mode is canceled and the off mode appears in the display for 2 seconds.
- * If the error display “- -: -” appears, these modes (Scan/Repeat/Random) can be canceled while still in play mode.

Operations Common to Each Mode

To change settings

1. Press and hold the [DISP] button (1 sec.) to switch to the adjustment display.
2. Press [◀◀] or [▶▶] to select the "item name" as follows:
 "CLOCK" ↔ "SETTINGS" ↔ "SCRN SVR"
 ↔ "SCROLL" ↔ "DIMMER" ↔ "TEL-SP"
 ↔ "TEL-SW"
 * The adjustment item will be displayed for 2 seconds before showing the desired value.
3. Turn the [ROTARY] knob to select the desired value.
 * When "ENT" is flashing in the display, press the [ENT] button to adjust setting value.
4. After completing settings, press the [DISP] button to return to the previous mode.

● Setting the clock

- 2-1. Select "CLOCK".
- 3-1. Press the [ENT] button
- 3-2. Press [◀◀] or [▶▶] to select the hour or minute.
- 3-3. Turn the [ROTARY] knob to set the time.
 * The clock is displayed in 12-hour format.
- 3-4. Press the [ENT] button to store the time in memory and return to the previous mode.

Note:

- You cannot set the clock when it is displayed with only the car's ignition on. If the car's battery dies or is removed, or the unit is removed, the clock will be reset. If another button/operation is selected while setting the clock, the clock set mode is canceled.

● Displaying the settings

You can see the state of current settings at any operation mode.

- 2-1. Select "SETTINGS".
- 3-1. Turn the [ROTARY] knob to display the current settings.
 * When the setting is selected, the current state will be displayed after 1 second.

Example:

After 1 second:

M-3 EX

M-3 ON

● Turning the screen saver on/off

This unit has a screen saver function in which various patterns and random characters can be displayed on the operation status indication area. This function can be turned on/off. If a button is pressed while the screen saver is on, the corresponding operation display is shown for about 30 seconds, and then the display returns to the screen saver.

* The factory default setting is "ON".

- 2-1. Select "SCRN SVR".

- 3-1. Turn the [ROTARY] knob to select "ON" or "OFF".

● Setting title scroll method

Set how to scroll in CD-TEXT and MP3/WMA titles.

* The factory default setting is "ON".

- 2-1. Select "SCROLL".

- 3-1. Turn the [ROTARY] knob to select "ON" or "OFF".

- **ON:** Scroll automatically.
- **OFF:** Scroll 1 time only.

● Setting dimmer control

Dimmer control can be set "ON" or "OFF".

* The factory default setting is "ON".

- 2-1. Select "DIMMER".

- 3-1. Turn the [ROTARY] knob to select "ON" or "OFF".

● Setting car speaker output for cell phones

When the AUX input jack is used to connect an AUX BLUETOOTH BB (BLT370) (sold separately):

* The factory default setting is "RIGHT".

* To output the telephone calls, set cell phone interrupt to "ON".

- 2-1. Select "TEL-SP".

- 3-1. Turn the [ROTARY] knob to select "RIGHT" or "LEFT".

- **RIGHT:** Telephone calls can be heard on the front right speaker connected to this unit.
- **LEFT:** Telephone calls can be heard on the front left speaker connected to this unit.

● Cell phone interrupt setting

If you connect this unit and your cell phone with an optional cable, you can listen to your calls on your car speakers.

When the AUX input jack is used to connect an AUX BLUETOOTH BB (BLT370) (sold separately):

* The factory default setting is “OFF”.

2-1. Select “TEL-SW”.

3-1. Turn the [ROTARY] knob to select setting. When turning the [ROTARY] knob, the setting changes as follows:

“OFF” ↔ “ON” ↔ “MUTE”

- **OFF:** This unit continues normal operation even when the cell phone is used.
- **ON:** Telephone calls can be heard from the speakers connected to the unit.
 - * When listening to calls on your car speakers, turn the [ROTARY] knob to adjust the volume.
- **MUTE:** The sound from this unit is muted during telephone calls.

Note:

• If connecting a hands-free kit, make sure the setting is ON to receive telephone audio through the system.

AUX function

An external input jack (AUX) is provided on the front panel to allow playback of sound and music from external devices.

● Selecting AUX IN sensitivity

Make the following settings to adjust sensitivity when the sound from an external device is difficult to hear even after adjusting the volume.

* The factory default setting is “MID”.

1. Press and hold the [DISP] button (1 sec.).
2. Select “AUX SENS”.
3. Turn the [ROTARY] knob to select “HIGH”, “MID” or “LOW”.

Note:

• When AUX mode is selected, AUX IN sensitivity can be set.

7. ACCESSORIES

USB Operations

USB memory device operation

Note:

- The following operations are the same as CD mode:
 - * Titles up to 64 bytes can be displayed in USB mode.
 - * Pause
 - * Track selection
 - * Fast-forward/fast-reverse
 - * Scan play
 - * Repeat play
 - * Random play
 - * Folder selection
- See “CD/MP3/WMA Operations” (page 11-13) for details.

About USB memory

- USB stands for Universal Serial Bus, and refers to an external bus standard supporting data transfer rates of 12 Mbps.
- This unit is compatible with USB 1.1/2.0 with maximum data transfer rates of 12 Mbps.
- USB memory devices playable via the unit's USB cable are limited to those recognized as “USB mass storage class devices”; operation is not guaranteed with all USB memory devices.
 - * Devices compatible with “USB Mass Storage Class” can be used by connecting to the host device without special drivers or application software.
- Consult the manufacturer of your USB memory device for information regarding whether it is supported by “USB Mass Storage Class” standards.
- Audio files playable on this unit are limited to MP3/WMA files. For details, see “MP3/WMA” (page 11).
 - Copy-protected WMA files cannot be played on this unit.
- To prevent accidental loss of data, always back up important data on your computer.
- Connections to a computer, or through a USB hub device are not supported.

- When a USB memory device is composed of two or more drives, only one of the drives will be detected.
- USB memory devices with security functions are not supported.
- The order in which tracks are recorded may differ depending on the USB memory device (the actual playback order may not be the same as that indicated on your computer's display).

⚠ CAUTION

- **Insert and remove a USB memory device only when the device is not being accessed. Connecting/disconnecting the device at the following times may result in the loss of data:**
 - **If the USB memory device is removed or power is disconnected during writing to the device.**
 - **When the device is subject to static electricity or electric noise.**
- **Do not leave a USB memory device unattended in an automobile. Exposure to direct sunlight or high temperatures may cause deformation or other malfunction of the USB memory device.**

Connecting a USB memory device

1. Connect the USB memory device to the USB cable. Press the [SRC] button to switch the source to the device.

Playback will begin from the first file recorded on the device.

- * Always insert the device fully into the connector. Incomplete connections may cause the device not to be recognized.
- * Depending on the number of tracks recorded, some of time may be required until all tracks are read into the unit.

To listen to tracks on a connected USB memory device

1. Press the [SRC] button to switch sources. When USB memory device is selected, playback will begin from the location at which playback was previously stopped.
 - * When a USB memory device is disconnected and reconnected, playback will begin from the previous track of the USB memory device.

To stop play

1. Press the [SRC] button and switch the source to something other than the USB memory device.
2. Remove the USB memory device from the USB cable.

⚠ CAUTION

Do not remove the USB memory device while USB mode is selected, as it may result in loss of or damage to data on the USB memory device.

Always backup and save important data on your computer.

iPod Operations

This section describes operations when connected to an Apple iPod via the USB cable.

Notes:

- See the *iPod Owner's Manual* for details regarding operations.
- The unit will not operate, or may operate improperly with unsupported versions.
- For a list of Apple iPod models compatible with this unit, please contact your Clarion dealer or www.clarion.com.
- Made for iPod means that an electronic accessory has been designed to connect specifically to iPod and has been certified by the developer to meet Apple performance standards.
Apple is not responsible for the operation of this device or its compliance with safety and regulatory standards.
iPod and iTunes are trademarks of Apple Inc., registered in the U.S. and other countries.

Connecting an iPod

When an iPod is connected to the USB cable, the "Shuffle" setting on the iPod will become as follows:

- "Shuffle (Albums)" play → Random play
 - "Shuffle (Songs)" play → All random play
- The iPod has two modes: the "Play mode" and the "iPod menu mode" for selecting tracks. Switch between these modes by pressing the [BND] button.

Note:

- To connect an iPod, please use the USB cable that came with your iPod.

Select iPod mode

1. Press the [SRC] button.
Playback will begin from the last file that was played on the iPod.

Notes:

- The following operations in Play mode operate the same as in CD mode:
 - * **Track selection:** [◀◀], [▶▶]
 - * **Fast-forward/fast-reverse:** [◀◀], [▶▶]
 - * **Pause:** [ENT]
 - See "CD/MP3/WMA Operations" (page 11-13) for details.
- After a Podcast file has completed playback, the pause display, or the track-end position Play-Time display will appear. At that time, select a music file once again.
- If the iPhone is used for telephone call in the other operation mode and you wish to switch to the iPod mode, you must finish the telephone call and press the [ENT] button to enter the iPod mode.

Setting iPod simple mode

Use this function if you wish to operate through your iPod connected to this unit via the USB cable.

- * The factory default setting is "OFF".
1. Press and hold the [DISP] button (1 sec.).
 2. Press [◀◀] or [▶▶] to select "S-CTRL".
 3. Press the [ENT] button.
 4. Turn the [ROTARY] knob to select "ON" or "OFF".
 - **ON:** Operations can be made through your iPod.
 - **OFF:** Operations cannot be made through your iPod.
 5. Press and hold the [ENT] button (1 sec.) to store the setting and return to the previous mode.

Notes:

- When performing iPod operations using simple control mode, make the operations slowly. If repetitive operations are performed too quickly, unforeseen errors may occur.
- Some iPod models do not support this function. Consult your nearest Clarion dealer or website to confirm which models do not support this function.

Other various play functions (in Play mode)

Notes:

- These functions are not supported when in the iPod menu mode.
- The Random function set on the iPod remains the same after connecting/disconnecting of the iPod.
- The Repeat function on the iPod will be changed when the iPod is connected/disconnected to this unit.

● Repeat play

Play back one track repeatedly.

1. Press the [RPT] button.

● Random play

Play all albums within a selected category in random order. (Corresponds to “Shuffle (Albums)” command on iPod.)

1. Press the [RDM] button.

● All random play

Play all tracks within a selected category in random order. (Corresponds to “Shuffle (Songs)” command on iPod.)

1. Press and hold the [RDM] button (1 sec.).

● To cancel play

1. Press the same play button again.

Notes:

- If the repeat play mode is canceled, once all tracks within a selected category are played, playback will begin from the first track in the selected category.
- If ACC is switched off when playing the last track within a selected category in Random mode, playback will begin from a different track once ACC is turned back on.
- Though the default setting of an iPod is “All Repeat”, this indication is not displayed on the mode status.
- When performing operations using simple control mode, do not set the repeat off on the iPod.

Selecting category from the iPod menu

1. Press the [BND] button to select the iPod menu mode.

The iPod menu categories will be displayed.

Notes:

- Repeat and Random mode operations are not supported when in the iPod menu mode.
- In iPod menu mode, playback may not be performed if [◀◀] or [▶▶] is pressed or the [ROTARY] knob is turned quickly.

2. Turn the [ROTARY] knob to switch between categories.

The iPod menu categories change as follows:

“PLAYLIST” ↔ “ARTIST” ↔ “ALBUM” ↔ “SONG” ↔ “GENRE” ↔ “COMPOSER”...

Note:

The iPod menu mode can be canceled by performing one of the following operations:

- Press the [BND] button.
 - Press the [▶▶] button when the category select screen is displayed.
3. Press the [▶▶] button to select the category.
 4. When the track name display is showing, press the [▶▶] button.

Playback will begin from the first track in the selected category, and the iPod menu mode will be canceled.

* Subfolders may be displayed, depending on the category.

In this case, use the [ROTARY] knob to switch between subfolders and use the [▶▶] button to select the desired subfolder.

- * When the track name display is showing, press the [◀◀] button to return to the currently playing folder name display.
5. Use the [ROTARY] knob to select a track within a category.

iPod menu alphabet search

This function searches the subfolders for desired alphabetical letters.

1. Press the [BND] button to select the iPod menu mode.
2. Turn the [ROTARY] knob to switch between categories.
3. Press the [▶▶] button.
 - * Subfolders may be displayed, depending on the category.
 - In this case, you can use the [ROTARY] knob to switch between subfolders and use the [▶▶] button to enter the next subfolder layer.
4. Press and hold the [DISP] button (1 sec.).
5. Turn the [ROTARY] knob to select the desired letter to search.
6. Press the [DISP] button to perform search.
 - * During search, press the [DISP] button to cancel search.

Selecting category using preset memory

1. Press the **[BND]** button to select the iPod menu mode.

The category can be set as follows in the **[DIRECT]** (1-6) buttons.

[1] : PLAYLIST

[2] : ARTIST

[3] : ALBUM

[4] : SONG

[5] : GENRE

[6] : COMPOSER

2. Press the desired **[DIRECT]** (1-6) button to select the category.

* Subfolders may be displayed, depending on the category.

In this case, use the **[ROTARY]** knob to switch between subfolders and use the **[▶▶]** button to select the desired subfolder.

3. When the track name display is showing, press the **[▶▶]** button.

Playback will begin from the first track in the selected category, and the iPod menu mode will be canceled.

* Use the **[ROTARY]** knob to select a track within a category.

About title display

This unit supports the display of title information obtained from a connected iPod.

- Character code information is UTF-8; displayable characters include English alphanumerics, some symbols, and some umlaut characters.
- Unsupported characters will be replaced by asterisks (*).

8. TROUBLESHOOTING

	Problem	Cause	Measure
General	Power does not turn on. (No sound)	Fuse is blown.	Replace with a fuse of the same amperage. If the fuse blows again, consult your dealer.
		Incorrect wiring.	Consult your dealer.
	No sound when operating the unit with amplifiers or power antenna attached.	Power antenna lead is short circuited, or excessive current is required for remotely powering on the amplifiers or power antenna.	<ol style="list-style-type: none"> 1. Turn the unit off. 2. Remove all wires attached to the power antenna lead. Check each wire for possible short circuits using an ohm meter. 3. Turn the unit back on. 4. Reconnect each amplifier remote wire to the power antenna lead one by one. If the amplifiers turn off before all wires are attached, use an external relay to provide remote power-on voltage (excessive current required).
	Nothing happens when buttons are pressed. Display is not accurate.	Microprocessor malfunction due to noise, etc.	<ol style="list-style-type: none"> 1. Turn off power, then press the [RELEASE] button and remove the DCP. 2. Use a thin rod to hold reset button depressed (2 sec.). If the reset button is pressed when a disc is loaded, please eject the disc and load it once again before attempting to play it.
		DCP or main unit connectors are dirty.	Wipe dirt off with a soft cloth dampened with cleaning alcohol.
	No sound	The speaker protection circuit is operating.	<ol style="list-style-type: none"> 1. Turn down sound volume. Function can also be restored by turning power off and on again. (Speaker volume is reduced automatically when the speaker protection circuit operates). 2. If the sound is still muted, consult your dealer.
CD/MP3/WMA	No sound	MP3/WMA files are absent on disc.	Write MP3/WMA files onto disc properly.
		Files are not recognized as MP3/WMA files.	Use properly encoded MP3/WMA files.
		File system is not correct.	Use ISO9660 level 1, 2 or JOLIET or Romeo file system.
	Sound skips or is noisy.	CD is dirty.	Clean the CD with a soft cloth.
		CD is heavily scratched/warped.	Replace with a CD without scratches.
	Sound cuts out or skips. Noise is generated/noise is mixed with sound.	MP3/WMA files are not encoded properly.	Use properly encoded MP3/WMA files.
	Sound is poor when power is first turned on.	Condensation may form on the internal lens when the car is parked in a humid place.	Let dry for about 1 hour with power on.
Wrong file name	File system is not correct.	Use ISO9660 level 1, 2 or JOLIET or Romeo file system.	

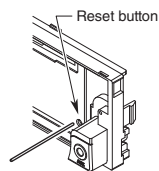

	Problem	Cause	Measure
USB/iPod	No sound	The device contains no MP3/WMA files.	Record MP3/WMA files properly to the device.
		The files are not proper MP3/WMA format.	Use properly encoded MP3/WMA files.
		Files are DRM copyright protected.	See page 11 for details on how to cancel DRM protection.
		Connectors are loose.	Disconnect the device and reconnect securely.
		Some USB portable music players may consume current that exceeds the USB rating. In this case, this unit's overcurrent protection circuit operates to stop the music playback.	Check operation of portable music player.
	Sound is interrupted or has noise.	MP3/WMA files are not encoded properly.	Use properly encoded MP3/WMA files.
	Device isn't recognized.	Device is damaged.	Disconnect and reconnect the device. If device still cannot be recognized, try replacing with different device.
		Connectors are loose.	
		According to the device's operation state, device may not be recognized.	Disconnect and reconnect the device.
	Cannot connect device to the USB cable.	Device has been connected improperly.	Connect the device in reverse direction.
Connector is broken.		Replace with a new device.	

9. ERROR DISPLAYS

If an error occurs, one of the following messages is displayed.

Take the measures described below to eliminate the problem.

	Error Display	Cause	Measure
CD/MP3/WMA	ERROR 2	A CD is caught inside the CD deck and is not ejected.	This is a failure of the CD deck mechanism. Consult your dealer.
	ERROR 3	A CD cannot be played due to scratches, etc.	Replace with a non-scratched, non-warped disc.
	ERROR 6	A CD is loaded upside-down inside the CD deck and does not play.	Eject the disc and reload properly.

	Error Display	Cause	Measure
USB/iPod	ERROR 2 (iPod mode)	During the iPod analyse, failure to achieve the iPod state or initialize the iPod driver, unusual detection of iPod driver.	Switch to the iPod mode again, reset the unit and iPod.
	ERROR 3 (iPod mode)	During the playback, failure to achieve the iPod state, unusual detection of iPod driver.	Switch to the iPod mode again.
	ERROR 5 (iPod mode)	The connected iPod is not recognized.	Disconnect and reconnect the iPod.
	ERROR 7 (USB mode)	USB memory device format error.	Disconnect and reconnect USB memory device. If device still cannot be recognized, try replacing with different USB memory device.

If an error display other than the ones described above appears, press the reset button. If the problem persists, turn off the power and consult your dealer.

10. SPECIFICATIONS

FM Tuner

Frequency Range: 87.9 MHz to 107.9 MHz
 Usable Sensitivity: 9 dBf
 50dB Quieting Sensitivity: 15 dBf
 Alternate Channel Selectivity: 70 dB
 Stereo Separation (1 kHz): 35 dB
 Frequency Response (± 3 dB): 30 Hz to 15 kHz

AM Tuner

Frequency Range: 530 kHz to 1710 kHz
 Usable Sensitivity: 25 μ V

CD Player

System: Compact disc digital audio system
 Usable Discs: Compact disc
 Frequency Response (± 1 dB): 5 Hz to 20 kHz
 Dynamic Range (1 kHz): 85 dB
 Harmonic Distortion: 0.01%

Audio

Maximum Power Output: 200 W (50 W \times 4 ch)
 Bass Control Action (100 Hz): +14 dB, -14 dB
 Treble Control Action (10 kHz): +14 dB, -14 dB
 Line Output Level (CD 1 kHz): 1.8 V

General

Power Supply Voltage:
 14.4 V DC (10.8 to 15.6 V allowable), negative ground
 Current Consumption: Less than 15 A
 Speaker Impedance: 4 Ω (4 Ω to 8 Ω allowable)
 Weight / Source unit: 2.69 lb. (1.22 kg)
 Weight / Remote control unit:
 1.41 oz. (40 g) (including battery)
 Dimensions / Source unit:
 7" (Width) \times 2" (Height) \times 6-1/8" (Depth)
 [178 (W) \times 50 (H) \times 155 (D) mm]
 Dimensions / Remote control unit:
 1-3/4" (Width) \times 4-5/16" (Height) \times 7/16" (Depth)
 [44 (W) \times 113 (H) \times 11 (D) mm]

Power Output :

20 W RMS \times 4 Channels at 4 and 1 % THD+N

Signal to Noise Ratio:

88 dBA (reference: 1 W into 4)



Note:

- Specifications and design are subject to change without notice for further improvement.

Clarion Co., Ltd.

All Rights Reserved. Copyright © 2008: Clarion Co., Ltd.
Printed in China / Imprimé en Chine / Impreso en China

PE-3157B
280-8687-00

2008/10